

**KIT VIDEOCITOFONICO MONO E BIFAMILIARE VIVAVOCE A COLORI**  
**ONE- AND TWO-HOUSEHOLD COLOUR HANDS-FREE VIDEO DOOR PHONE KIT**  
**KIT VIDÉO MONO ET BI-FAMILLE MAINS LIBRES COULEUR**  
**KIT VIDEOINTERFÓNICO MONO Y BIFAMILIAR A COLORES CON ALTA VOZ**  
**FARB-VIDEOSPRECHANLAGE-KIT FÜR EIN- UND ZWEIFAMILIENHAUS**  
**HANDENVRIJE EEN- EN TWEEGEZINS-KLEURENVIDEOKIT**

Sch./Ref. 1722/85 - 1722/86 (\*)

**IP44**

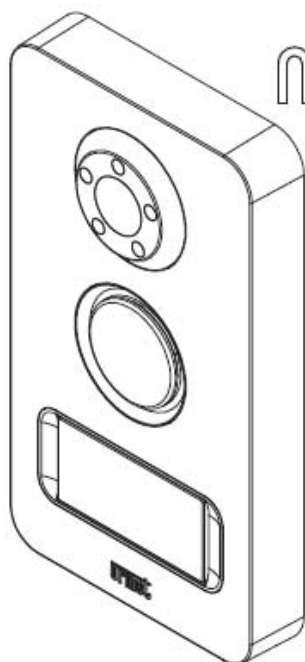

**mikra**

**cxmodo**

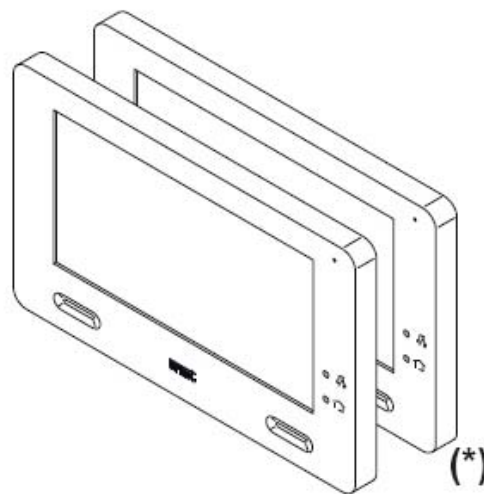

**GUIDA RAPIDA PER L'UTILIZZO DEL VIDEOCITOFONO**  
**VIDEO DOOR PHONE QUICK USER'S GUIDE**  
**GUIDE RAPIDE D'UTILISATION DU MONITEUR**  
**GUÍA RÁPIDA DE USO DEL VIDEOINTERFONO**  
**KURZANLEITUNG FÜR DIE VERWENDUNG DER VIDEOSPRECHANLAGE**  
**SNELGIDS VOOR HET GEBRUIK VAN DE VIDEO-DEURINTERCOM**

<b>ITALIANO</b>	<b>3</b>
<b>ENGLISH</b>	<b>7</b>
<b>FRANÇAIS</b>	<b>11</b>
<b>ESPAÑOL</b>	<b>15</b>
<b>DEUTSCH</b>	<b>19</b>
<b>VLAAMS</b>	<b>27</b>

**DESCRIZIONE DEI COMPONENTI**  
**DESCRIPTION OF COMPONENTS**  
**DESCRIPTION DES COMPOSANTS**  
**DESCRIPCIÓN DE LOS COMPONENTES**  
**BESCHREIBUNG DER KOMPONENTEN**  
**OMSCHRIJVING VAN DE ONDERDELEN**

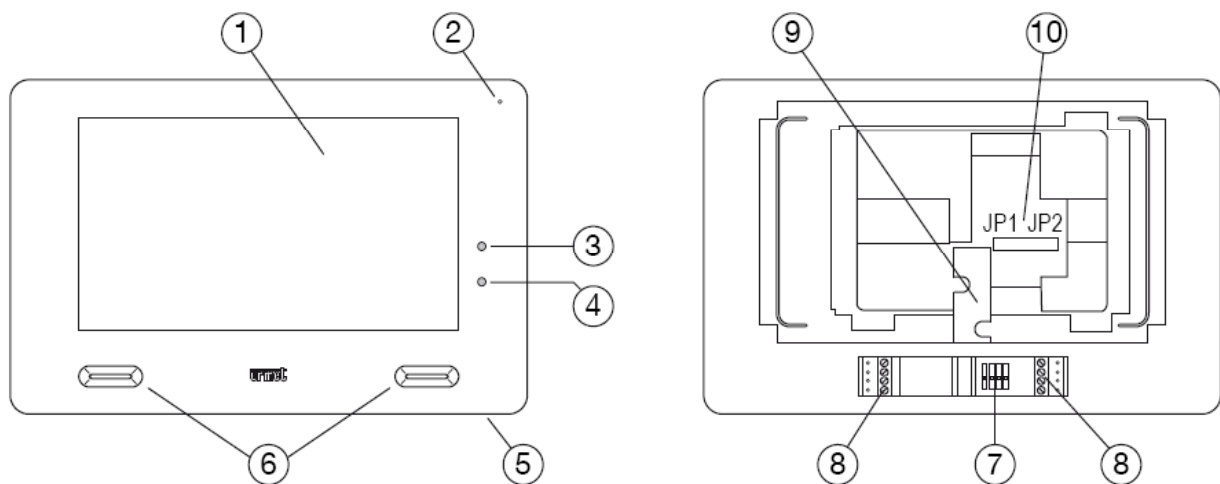

1. Display touchscreen 7" / 7" *touchscreen display* / Écran tactile 7" / Pantalla táctil 7" / 7"-Touchscreen-Display / 7" aanraakscherm
2. Microfono / *Microphone* / Micro / *Micrófono* / Mikrofon / *Microfoon*
3. Led rosso di segnalazione mute attivo / *Active Mute red indicator LED* / Voyant rouge de Silence actif / *Indicador rojo led mute activo* / Rote Stummschaltungs-LED aktiv / *Rood waarschuwinglampje mute-functie aan*
4. Led blu di conferma comando Yokis inviato / *Sent Yokis control confirmation blue LED* / Voyant bleu de confirmation commande Yokis envoyée / *Led azul de confirmación de mando Yokis enviado* / Blaue Bestätigungs-LED Yokis-Befehl gesendet / *Blauwe led bevestiging Yokis commando verzonden*
5. Pulsante ON/OFF / *ON/OFF button* / Bouton ON/OFF / *Botón ON/OFF* / Taste EIN/AUS / *AAN/UIT knop*
6. Altoparlanti / *Speakers* / Haut-parleurs / *Altavoces* / Lautsprecher / *Luidsprekers*
7. Dip-switch di configurazione / *Configuration dip-switch* / Commutateur de configuration / *Dip switch de configuración* / Konfigurations-Dip-Switch / *Configuratie dip-schakelaars*
8. Morsettiere di collegamento / *Connection terminal strips* / Bornier de branchement / *Terminales de conexión* / Anschlussklemmen / *Klemmenbord*
9. Passaggio per cavi / *Cable guide* / Passage des câbles / *Conductos de cables* / Durchlass für Kabel / *Passage voor kabels*
10. Ponticelli di configurazione / *Configuration jumpers* / Pontets de configuration / *Puentes de configuración* / Konfigurationsbrücken / *Configuratiejumpers*

## 1 FUNZIONALITÀ

### COME ACCENDERE LO SCHERMO E ACCEDERE ALLE VARIE FUNZIONI

- Toccare lo schermo in un punto qualsiasi, oppure
- Premere il pulsante (5) in basso a destra del monitor, che farà apparire la Home Page.

La Home Page è la seguente:



da cui è possibile accedere alle seguenti funzioni:



Visualizzare le immagini riprese dalla telecamera.



Silenziare la chiamata (Mute) al monitor (l'attivazione della funzione è evidenziata dall'accensione del led rosso di segnalazione 3 e dal lampeggio dell'icona Mute).



Accedere alla videata della Domotica Yokis.



Visualizzare un'istantanea fra quelle già salvate nella galleria delle immagini.



Effettuare una chiamata intercomunicante ad altri utenti dello stesso appartamento o fra utenti di appartamenti diversi.



Spegnere lo schermo.



Variare le impostazioni del monitor.



Ora corrente.

## 1.1 COME SPEGNERE LO SCHERMO

Per spegnere lo schermo premere il tasto (5) del Monitor o attendere il timeout.

## 1.2 COME RISPONDERE A UNA CHIAMATA PROVENIENTE DALL'ESTERNO

Quando il Monitor CXModo riceve una chiamata videocitfonica esterna squilla e si accende lo schermo, che è normalmente spento.





Toccando le varie icone si può:

 Rispondere alla chiamata e iniziare la conversazione in viva voce; in seguito per chiudere la chiamata ripremere la stessa icona, lo schermo si spegne.

 Aprire la porta.

 Aprire il cancello dell'eventuale passo carraio.

 Attivare una funzione ausiliaria, ad esempio l'accensione delle luci scala.

 Aprire un sottomenù nel quale si può:

 Modificare il volume dell'audio dal posto di chiamata verso il monitor oppure la luminosità, il contrasto e il colore del display.

 Ingrandire o rimpicciolire l'immagine, cambiandone anche l'aspetto da 4:3 a 16:9.

 (Non usare: predisposizione per implementazioni future.)

 Memorizzare un'istantanea dell'immagine esterna visualizzata sullo schermo.

 Escludere o riattivare il microfono del monitor, per evitare che chi chiama possa sentire ciò che si dice. L'icona è attiva solo dopo aver risposto.

 Richiudere il sottomenù precedente.

### 1.3 COME ATTIVARE UN COMANDO YOKIS



Dalla Home Page premere il pulsante  per accedere la Domotica Yokis:

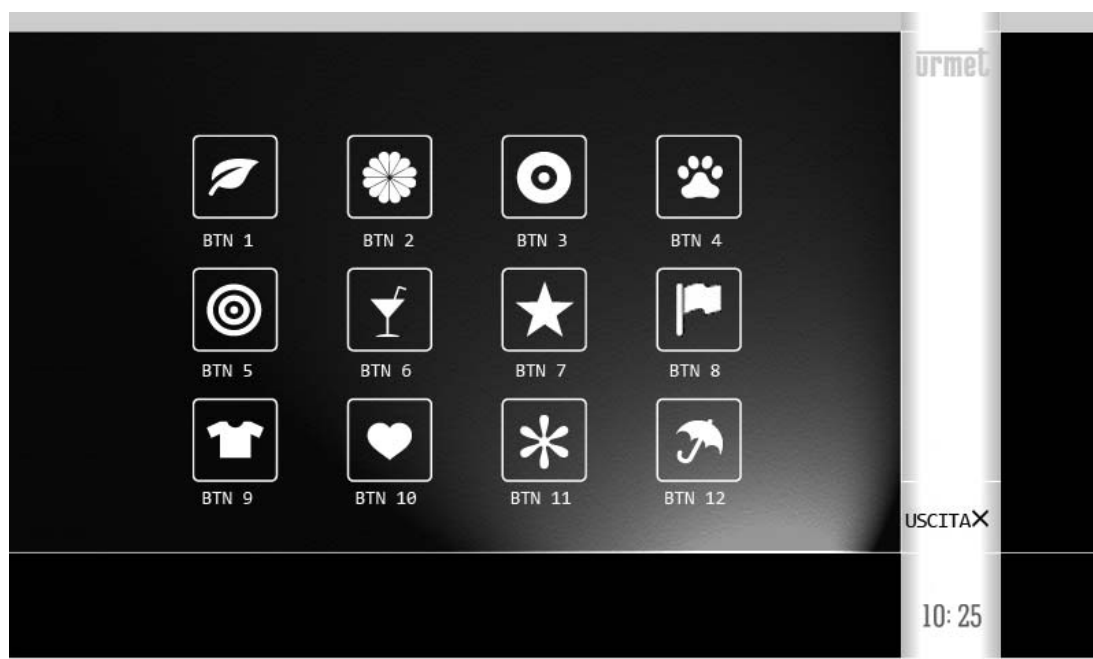

Da qui selezionare il comando o i comandi desiderati.

Per schedulare un comando in una o più occorrenze settimanali, dalla Home Page del monitor, premere



l'icona 'Impostazioni' e poi selezionare 'Yokis'. Si accederà così alla pagina seguente:



Selezionare il pulsante che si vuole schedulare, ad es. il primo. Comparirà:



Toccare l'icona  e nella videata seguente selezionare ora e giorni della schedulazione:

**ATTENZIONE:** la schedulazione diviene attiva solo se anche il quadratino di 'ABILITA' è contrassegnato dal segno di spunta.



Per tornare alla Home Page, premere 2 volte 'OK' per confermare le modifiche e poi 2 volte 'USCITA'.

Per maggiori informazioni inquadrare il QR Code seguente con la fotocamera del proprio smartphone o tablet :



### HOW TO TURN ON THE SCREEN AND ACCESS THE VARIOUS FUNCTIONS

- Tap the screen at any point, or
- Press the button (5) at the bottom right of the screen to bring up the Home Page.

The Home Page is the following:

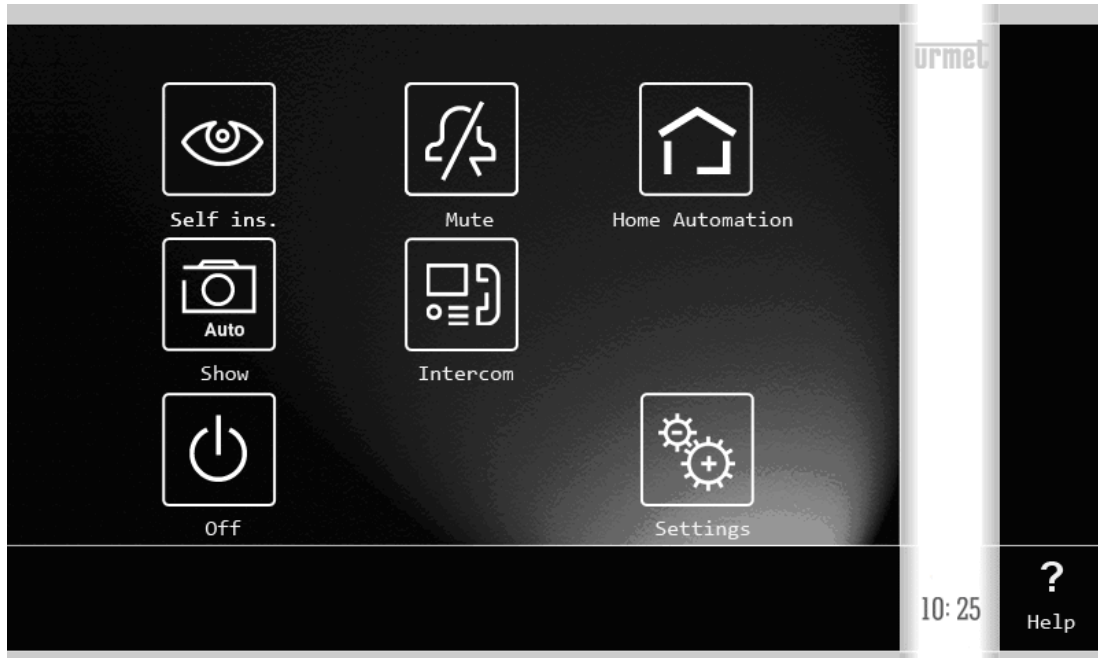

and gives access to the following functions:



View footage from the video camera.



Mute the call (Mute) to the monitor (the activation of this function is highlighted by the red indicator LED 3 lighting up and by the flashing of the Mute icon).



Access the Yokis Home Automation screen page.



View a snapshot from among those already saved to the photo gallery.



Make an intercom call to other users in the same apartment or between users in different apartments.



Turn off the screen.



Change monitor settings



Current time.



## 2.1 HOW TO TURN OFF THE SCREEN

To turn off the screen press the Monitor button (5) or wait for the timeout delay.

## 2.2 HOW TO ANSWER AN EXTERNAL CALL

When the CXModo Monitor receives an outdoor door phone video call, it rings and the screen lights up from its default switched-off state.



By tapping the various icons you can:

 Answer the call and begin a hands-free conversation; then, to end the call press the same icon once again, the screen will turn itself off.

 Open the door.

 Open a driveway or garage gate.

 Activate an auxiliary function, e.g. turning on the stair lights.

 Open a submenu where you can:

 Change the audio volume in the calling point-to-monitor direction, or the brightness, contrast, and colour of the display.

 Enlarge or shrink the image, also changing its format from 4:3 to 16:9.

 (Do not use: pre-setting for future functions.)

 Store a snapshot of the outdoor picture displayed on the screen.

 Turn the monitor microphone off and then back on, to prevent the caller hearing what you are saying. The icon will only be active after the call has been answered.

 Close the previous submenu.



## 2.3 HOW TO ACTIVATE A YOKIS CONTROL



From the Home Page press the button to access Yokis Home Automation:

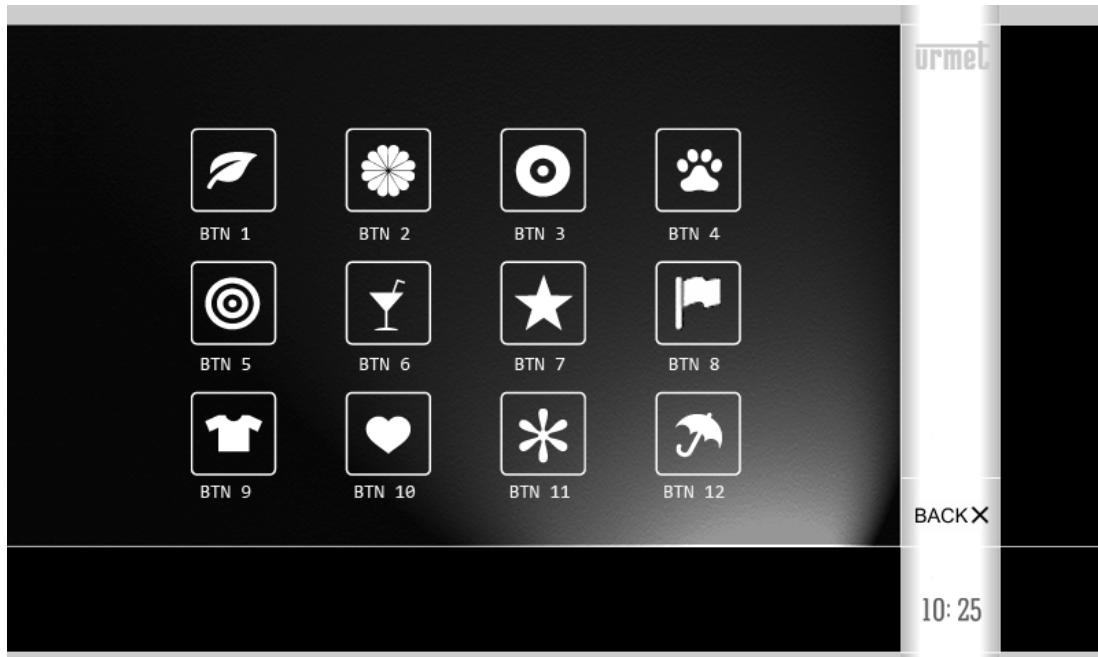

From here, select your required control(s).

To schedule a control for one or more weekly occurrences, from the Home Page of the monitor, press the icon



'Settings' and then select 'Yokis'. You will obtain access to the following page:

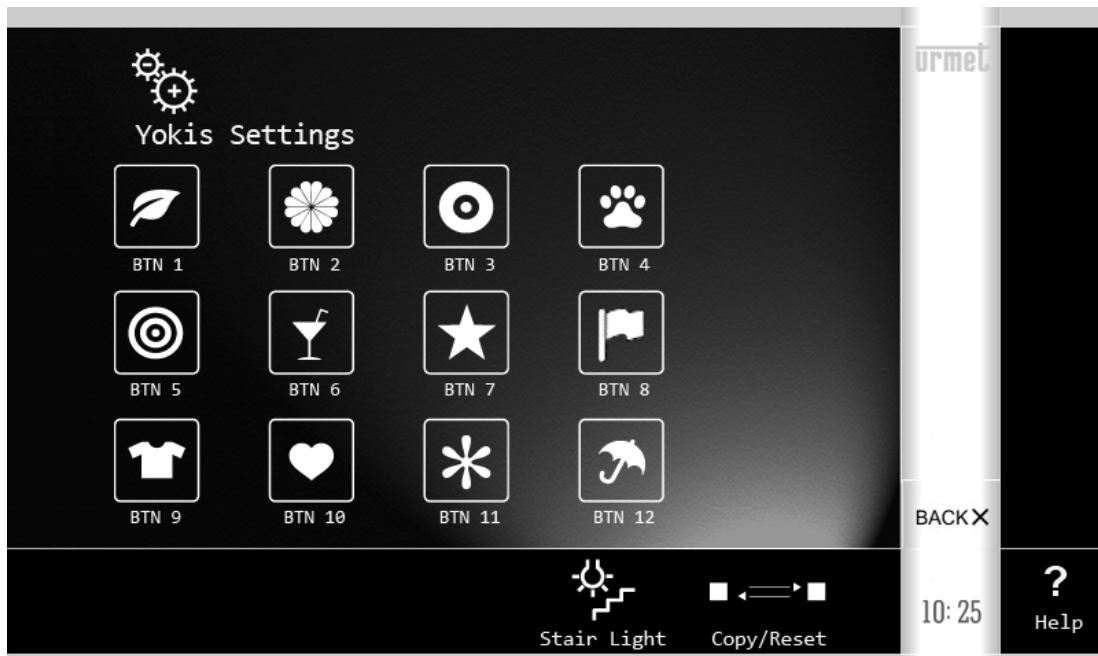

Select the button that you wish to schedule, e.g. the first one. You will display:

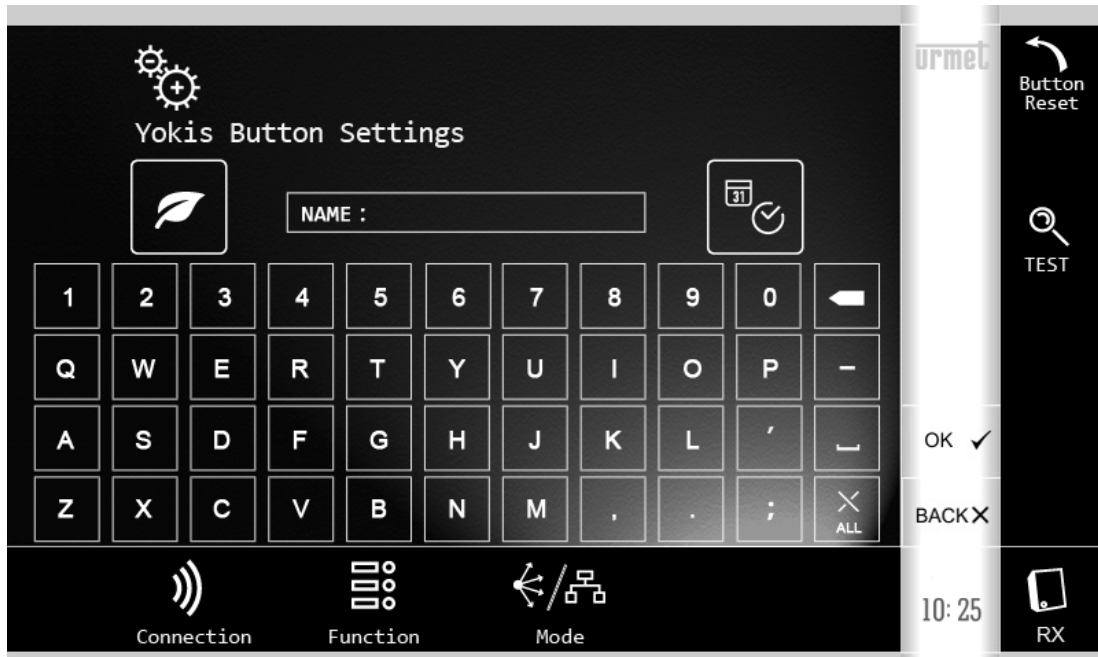

Tap the icon and select the scheduling time and days in the following screen:

**NOTE THAT** the scheduling only becomes active if the 'Enable' box is ticked, too.

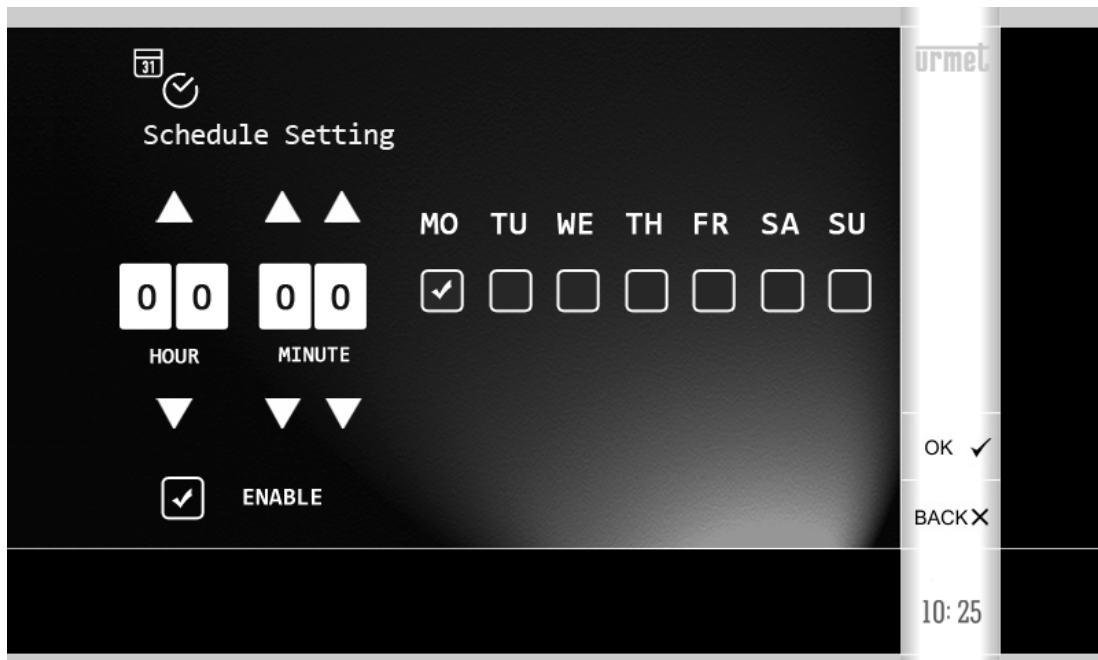

To return to the Home Page, press 'OK' twice to confirm the changes and then 'BACK' twice.

For more information scan the QR Code below with your smartphone or tablet:



### COMMENT ALLUMER L'ÉCRAN ET ACCÉDER AUX DIFFÉRENTES FONCTIONS

- Toucher l'écran à n'importe quel endroit ou bien
- Appuyer sur le bouton (5) en bas à droite du dispositif pour afficher la page d'accueil (Home Page).

La page d'accueil est la suivante :



depuis cette page, il est possible d'accéder aux fonctions suivantes :



Visualiser la caméra de la plaque de rue.



Activer sur le moniteur la fonction Silence (l'activation de la fonction est indiquée par l'allumage du voyant indicateur rouge 3 et par le clignotement de l'icône Silence).



Accéder à la page Domotique Yokis.



Visualiser une capture parmi celles précédemment sauvegardées dans la galerie des images.



Effectuer un appel Intercom d'autres utilisateurs du même appartement ou entre utilisateurs d'appartements différents.



Éteindre l'écran.



Modifier les réglages du moniteur.



10:25 Heure actuelle.

### 3.1 COMMENT ÉTEINDRE L'ÉCRAN

Pour éteindre l'écran, appuyer sur la touche (5) du dispositif ou attendre le timeout.

### 3.2 COMMENT RÉPONDRE A UN APPEL PROVENANT DE L'EXTÉRIEUR

Quand le moniteur CXModo reçoit un appel vidéo externe, il sonne et l'écran (normalement éteint) s'allume.





En touchant les différentes icônes, il est possible de :

 Répondre à l'appel et entamer la conversation en mode mains libres; ensuite, pour mettre fin à l'appel, appuyer à nouveau sur l'icône (l'écran s'éteint).

 Ouvrir la porte.

 Ouvrir la grille de l'éventuel accès voiture.

 Activer une fonction auxiliaire, par exemple l'allumage de la lumière des escaliers ou extérieure par exemple.

 Ouvrir un sous-menu permettant de :

 Modifier le volume audio depuis la plaque de rue vers le moniteur ou la luminosité, le contraste et la couleur de l'écran.

 Agrandir ou réduire l'image, en en modifiant l'aspect de 4:3 à 16:9.

 (Non utilisé: pour applications futures).

 Mémoriser une capture de l'image extérieure affichée sur l'écran.

 Exclure ou réactiver le micro du moniteur, pour éviter que l'appelant ne puisse entendre les voix venant de l'intérieur. L'icône est active uniquement après avoir répondu.

 Fermer le sous-menu précédent.

### 3.3 COMMENT ACTIVER UNE COMMANDE YOKIS



Depuis la page d'accueil, appuyer sur l'icône pour accéder à la Domotique Yokis :

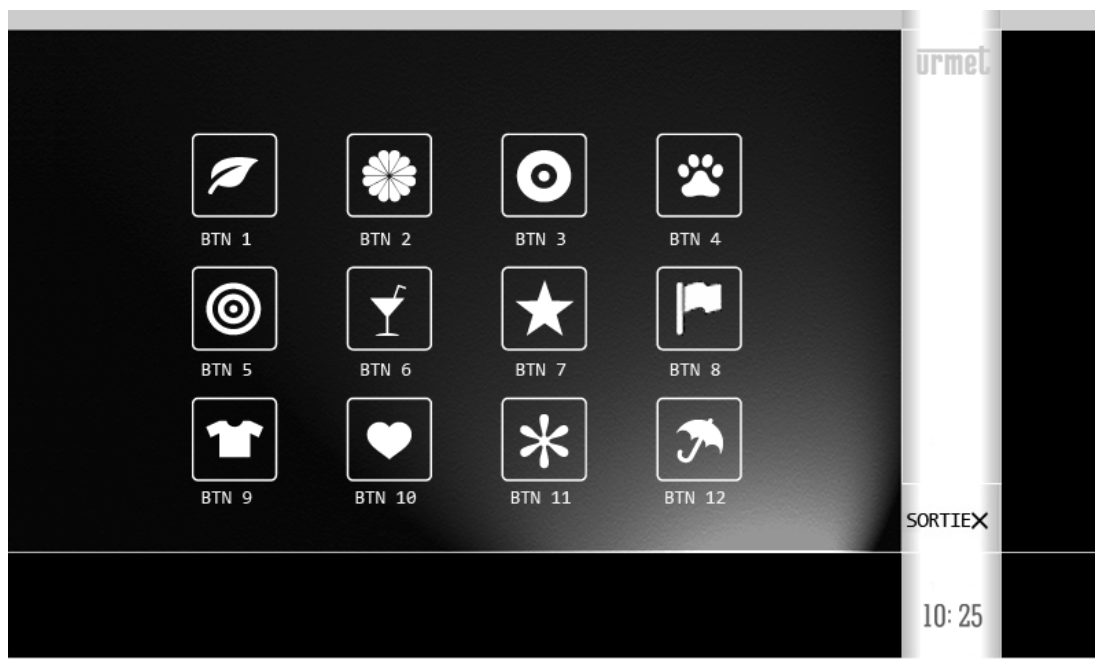

Ensuite, sélectionner la ou les commandes voulues.

Pour programmer une commande à un ou différents moments de la semaine, depuis la page d'accueil du



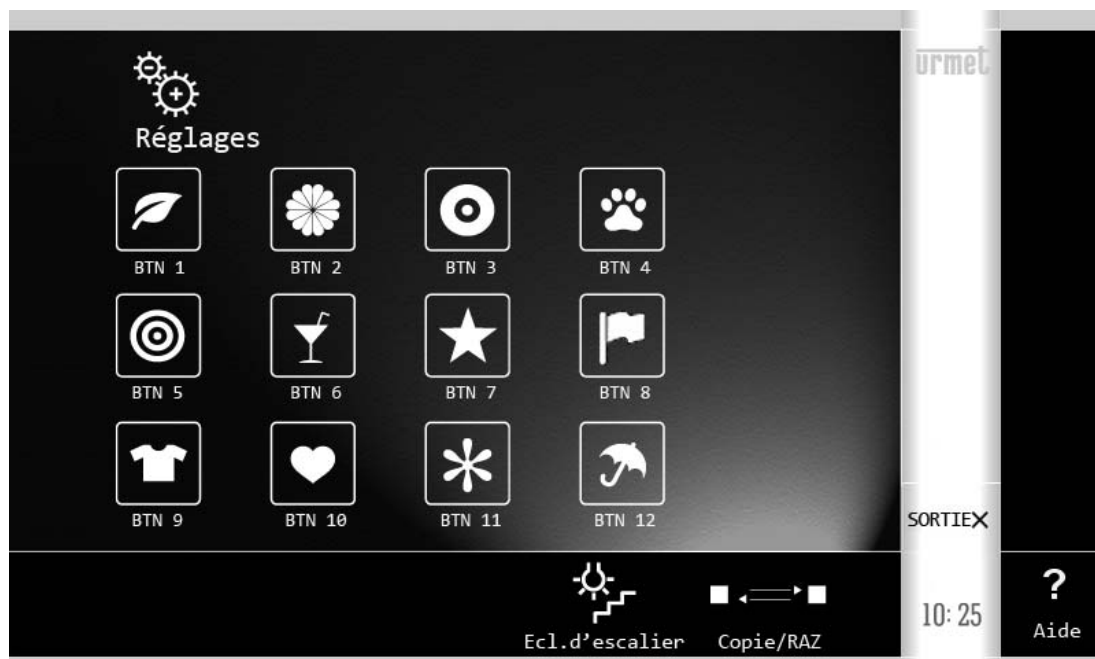

dispositif, appuyer sur l'icône Réglages puis sélectionner Domotique . On accède alors à la page suivante :



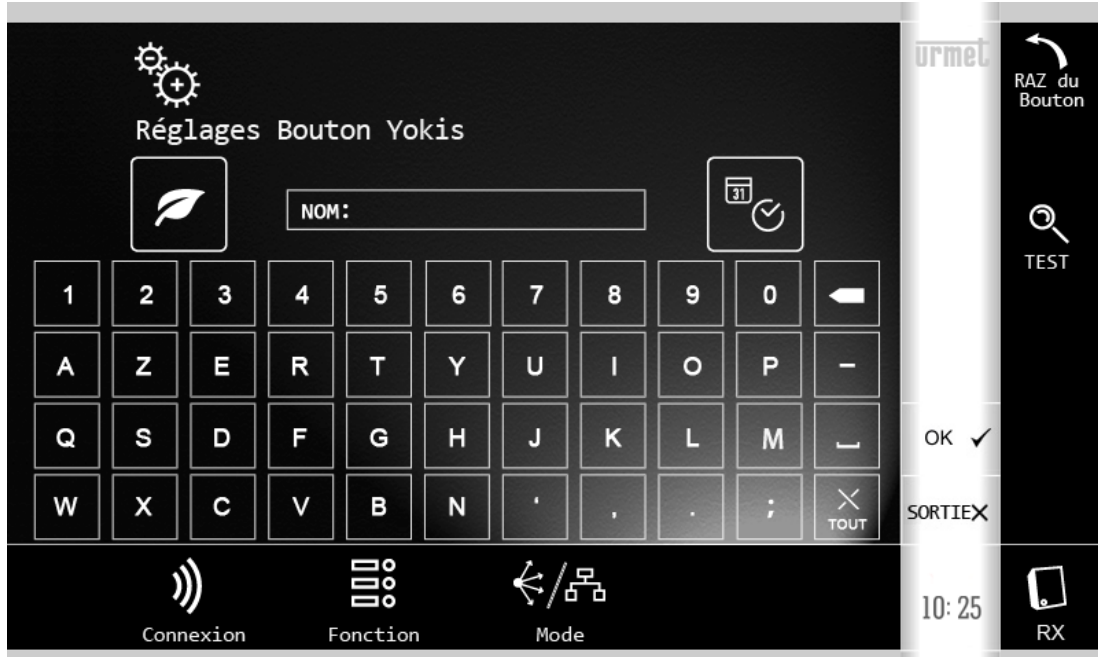

Sélectionner le bouton à programmer, par exemple le premier. Ensuite, s'affiche la page suivante :



Toucher l'icône  et sur la page suivante, sélectionner heure et jours de la programmation :

**ATTENTION:** la programmation devient active uniquement quand la case ACTIF est cochée.



Pour revenir à la page d'accueil, appuyer 2 fois sur OK pour confirmer les modifications et 2 fois sur SORTIE.

Pour plus d'informations, cadrer le Code QR e suivant avec l'appareil-photo d'un smartphone ou d'une tablette :





## 4 FUNCIONALIDAD

### CÓMO ENCENDER LA PANTALLA Y ACCEDER A LAS DIFERENTES FUNCIONES

- Pulse la pantalla en cualquier lugar, o
- Pulse el botón central (5) en la parte inferior del monitor, para mostrar la página de inicio.

La página de inicio es la siguiente:



desde la cual se pueden acceder a las siguientes funciones:



Ver las imágenes que se filman desde las cámaras de vídeo.



Silenciar la llamada para revisar (la activación de la función se evidencia por la iluminación del led rojo indicador 3 y del icono parpadeante “Silenciar”).



Iniciar sesión en la pantalla de la Domótica Yokis



Ver una instantánea de las que ya ha guardado en la galería de imágenes



Realizar una llamada a otros usuarios en el mismo apartamento o entre usuarios de diferentes apartamentos.



Apagar la pantalla.



Cambiar la configuración del monitor.



Hora actual.

## 4.1 CÓMO APAGAR LA PANTALLA

Para apagar la pantalla pulse el botón (5) del Monitor o espere el tiempo de espera .

## 4.2 CÓMO CONTESTAR UNA LLAMADA EXTERNA

Cuando el Monitor CXModo recibe una llamada de video externa suena y se ilumina la pantalla, que está normalmente apagada.





Al pulsar los diferentes iconos se puede:

 Responder a la llamada e iniciar conversación en altavoz; luego puede finalizar la llamada, pulsando el mismo icono, la pantalla se apaga.

 Abrir la puerta.

 Abrir la puerta de cualquier entrada.

 Activar una función auxiliar, por ejemplo encender las luces.

 Abrir un submenú donde se puede:

 Cambiar el volumen del audio del puesto de llamada al monitor o cambiar la luminosidad, el contraste y el color de la pantalla.

 Ampliar o reducir la imagen, cambiando el formato de 4:3 a 16:9.

 (No establecer la configuración para implementaciones futuras).

 Guardar una instantánea de la imagen externa que se muestra en la pantalla.

 Silenciar o activar el micrófono del monitor, para evitar que las personas que llamen puedan escuchar lo que se dice. El icono se activa solo después de responder.

 Cerrar el submenú anterior.

### 4.3 CÓMO ACTIVAR UN COMANDO YOKIS



Desde la Página de inicio pulse el botón para acceder a la domótica Yokis:

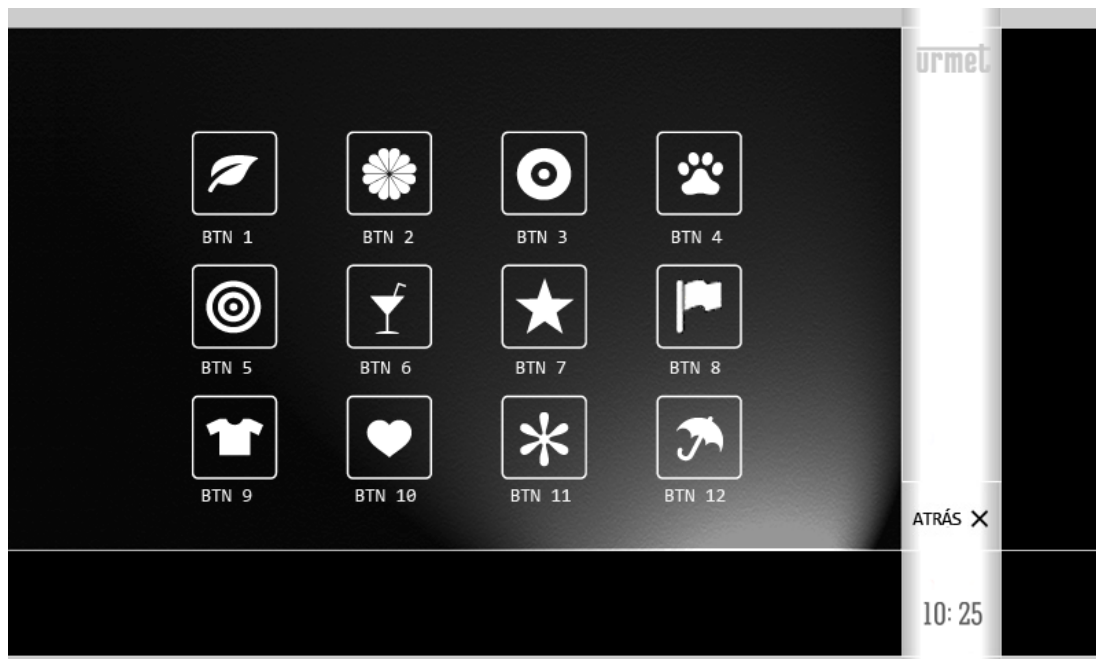

Desde aquí seleccione el comando o comandos deseados.

Para programar un comando en uno o más eventos semanales desde la página de inicio de la pantalla, pulse



el icono "Ajustes"

y después seleccione 'Yokis'



Le llevará a la página siguiente:



Seleccione el botón que desea programar, por ejemplo. el primero. Aparecerá:



Pulse el icono  y en la siguiente pantalla, seleccione la hora y el día de la programación:

**ATENCIÓN:** la programación se activa solo si el recuadro 'Habilitar' está marcado con una marca de verificación.



Para volver a la página de inicio, pulse 2 veces 'Aceptar' para confirmar los cambios y luego 2 veces 'Atrás'.

Para mayor información vea el siguiente código QR con la cámara de su smartphone o tablet: con la cámara de su smartphone o tablet:



### EINSCHALTEN DES BILDSCHIRMS UND ZUGRIFF AUF DIE VERSCHIEDENEN FUNKTIONEN

- Tippen Sie auf einen beliebigen Punkt im Bildschirm oder
- Drücken Sie die Taste (5) in der unteren rechten Ecke des Monitors, dies wird die Homepage erscheinen lassen.

Die Homepage ist folgende:



Von hier aus können Sie auf folgende Funktionen zugreifen:



Die von der Kamera aufgenommenen Bilder anzeigen



Stummschalten des Anrufs an den Monitor (die Aktivierung der Funktion wird durch Einschaltung der roten Signal-LED 3 und Blinken des Symbols Stummschaltung signalisiert).



Auf die Eingabemaske von Yokis Domotik zugreifen.



Eine der bereits in der Bildergalerie gespeicherten Momentaufnahmen anzeigen



Einen Intercom-Anruf an andere Benutzer der gleichen Wohnung oder zwischen den Benutzern verschiedener Wohnungen tätigen.



Den Bildschirm ausschalten



Die Monitoreinstellungen ändern



Uhrzeit



## 5.1 BILDSCHIRM AUSSCHALTEN

Zum Ausschalten des Bildschirms die Taste (5) des Monitors drücken oder den Timeout abwarten.

## 5.2 ANNAHME EINES EXTERNEN ANRUFES

Wenn ein externer Anruf der Videosprechanlage am Monitor CXModo eingeht, klingelt und schaltet sich der normalerweise ausgeschaltete Bildschirm ein.



Durch Antippen der verschiedenen Symbole kann man Folgendes:



Den Anruf entgegennehmen und das Gespräch über die Freisprechanlage beginnen; um das Gespräch später zu beenden, drücken Sie nochmals auf das gleiche Symbol, der Bildschirm schaltet sich aus.



Die Tür öffnen.



Das Tor einer eventuellen Toreinfahrt öffnen.



Eine Hilfsfunktion aktivieren, z.B. die Einschaltung des Treppenlichts.



Ein Untermenü mit den folgenden Möglichkeiten öffnen:



Die Lautstärke von der Anrufstation an den Monitor oder die Helligkeit, Kontrast und Farbe des Displays regeln.



Das Bild vergrößern oder verkleinern und auch sein Format von 4:3 auf 16:9 ändern.



(Nicht verwenden: Voreinstellung für zukünftige Implementierungen)



Einen Schnappschuss des auf dem Bildschirm angezeigten externen Bildes speichern.



Das Mikrofon des Monitors aus- bzw. wieder einschalten, um zu verhindern, dass der Anrufer mithören kann. Das Symbol ist erst aktiv, nachdem geantwortet wird.



Das vorherige Untermenü wieder schließen.



### 5.3 AKTIVIERUNG EINES YOKIS-BEFEHLS



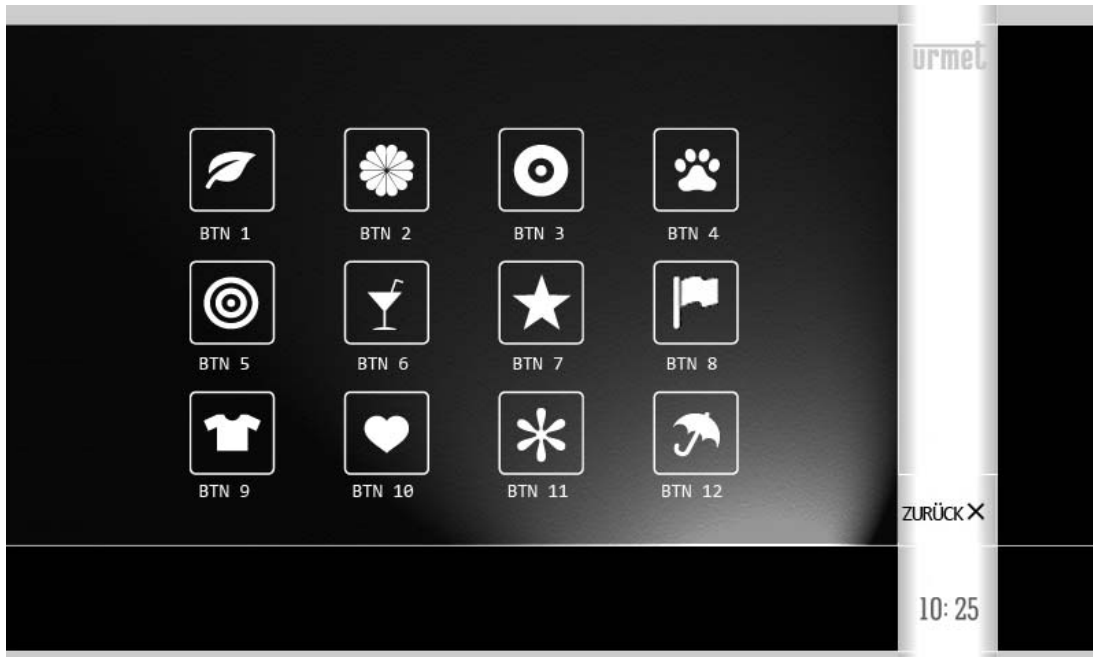

Auf der Homepage die Taste  drücken, um auf Yokis Domotik zuzugreifen:



Wählen Sie hier den/die gewünschten Befehl(e).

Um einen Befehl mit einer oder mehrerer wöchentlicher Wiederholung(en) zu programmieren, drücken Sie auf



der Homepage des Monitors das Symbol 'Einstellungen'  und wählen Sie dann 'Yokis' aus . Sie gelangen so auf die folgende Seite:

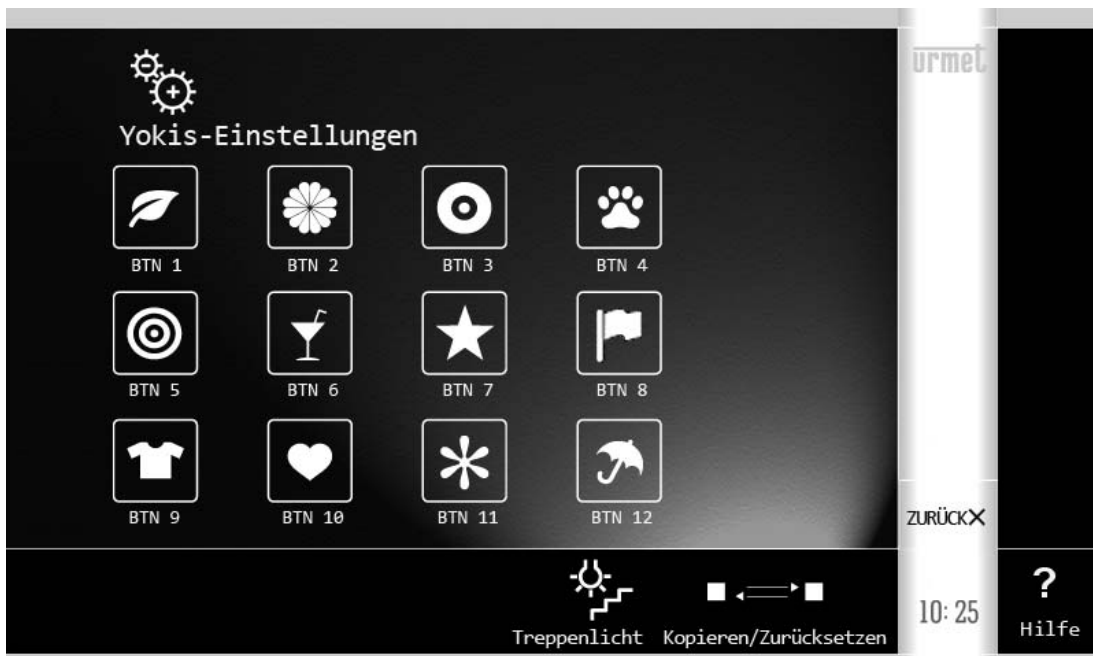

Wählen Sie die Taste aus, die Sie programmieren wollen, z.B. die erste. Es erscheint Folgendes:



Das Symbol antippen und auf der nachfolgenden Uhrzeit und Tage der Timereinstellung auswählen:

**ACHTUNG:** Die Timereinstellung ist nur aktiv, wenn auch das Kästchen 'Freigabe' mit einem Häkchen markiert ist.



Um zur Homepage zurückzukehren, drücken Sie zweimal 'OK', um die Änderungen zu bestätigen, und dann zweimal 'Zurück'.

Für weitere Informationen den folgenden QR-Code mit Ihrer Smartphone- oder Tablet-Kamera aufnehmen :



# 1 FUNCTIES

## TOEGANG TOT HET SCHERM EN TOT DE DIVERSE FUNCTIES

- Raak het scherm op een willekeurig punt aan, of
- Druk op de toets (5) onderaan rechts van de monitor om de Home Page (startpagina) op te roepen.

Dit is de Home Page:



van waaruit u toegang heeft tot de volgende functies:



Weergave van de beelden die door de camera worden opgenomen.



Het oproepsignaal deactiveren (Stil-functie) vanaf de monitor (bij inschakeling van deze functie gaat de rode waarschuwingsled (3) branden en knippert het Stil pictogram).



Toegang tot het schermbeeld van Yokis huisautomatisering.



Een momentopname onder de afbeeldingen die al opgeslagen zijn in de betreffende galerij weergeven.



Een intercom oproep maken naar andere gebruikers in hetzelfde appartement of onderling tussen gebruikers van verschillende appartementen.



Het scherm uitschakelen.



De instellingen van de monitor wijzigen.



Huidige tijd.

## 1.1 HET SCHERM UITSCHAKELLEN

Om het scherm uit te schakelen, druk op de toets (5) van de monitor of wacht de uitschakeltijd.

## 1.2 EEN OPROEP VAN BUITENAF BEANTWOORDEN

Wanneer de monitor CXModo een beeldoproep van buitenaf ontvangt, weerklinkt een belsignaal en licht het scherm op dat normaal gedoofd is.





Door de verschillende symbolen aan te raken, kunt u:

 Een oproep beantwoorden en een handsfree gesprek voeren; druk hierna op hetzelfde pictogram om het gesprek te beëindigen, het scherm dooft.

 De deur openen.

 Het hek van de eventuele oprit openen.

 Een extra functie activeren, bijvoorbeeld de trapverlichting inschakelen.

 Een submenu openen waar u het volgende kunt doen:

 Het volume vanaf de plaats van oproep naar de monitor of de helderheid, het contrast en de kleur van het scherm regelen.

 Het beeld vergroten of verkleinen en de weergave wijzigen van 4:3 naar 16:9.

 (Niet gebruiken: bestemd voor toekomstige implementaties.)

 Een momentopname maken van het externe beeld dat op het scherm wordt getoond.

 De microfoon van de monitor uit- en opnieuw inschakelen, om te voorkomen dat degene die belt hoort wat er gezegd wordt. Het pictogram is alleen actief nadat u heeft opgenomen.

 Het vorige submenu opnieuw sluiten.

### 1.3 EEN YOKIS-COMMANDO ACTIVEREN



Vanaf de Home Page, druk op de knop  om toegang te krijgen tot de Yokis huisautomatisering:

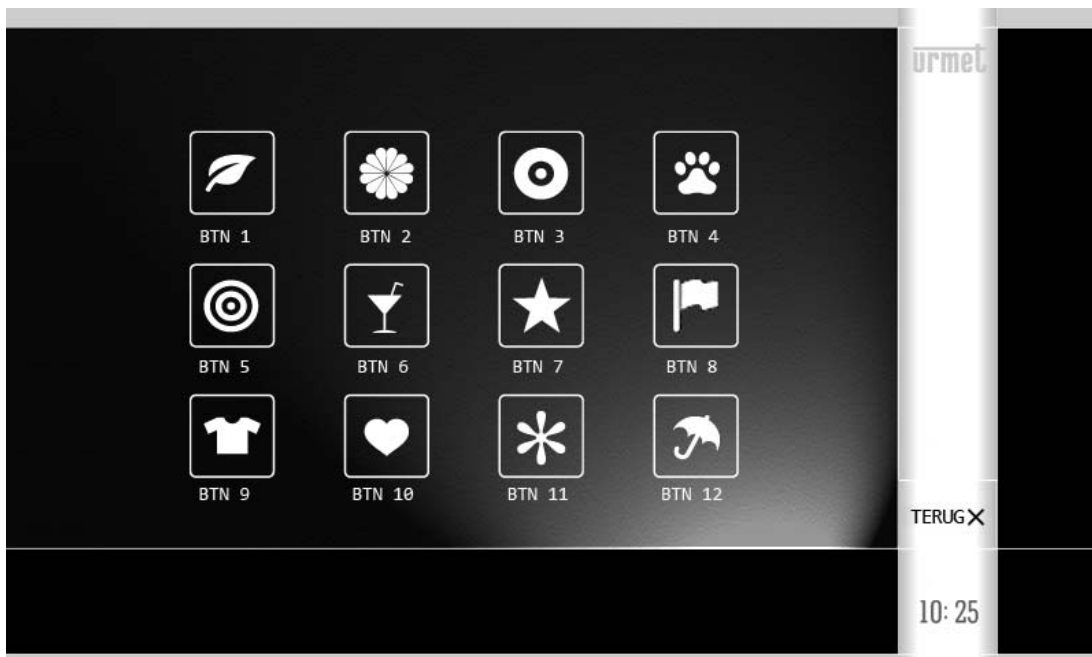

Hier kunt u de gewenste commando of commando's kiezen.

Om een commando één of meerdere keren per week te plannen, druk vanaf de Home Page van de monitor op



het pictogram 'Instellingen'

en kies vervolgens 'Yokis'



. De volgende pagina wordt geopend:



Kies de toets waarvoor u een planning wilt aanmaken, bijvoorbeeld de eerste. Het volgende scherm verschijnt:



Tik op het pictogram  en selecteer in het volgende scherm het tijdstip en dag van de planning:

**OPGELET:** de planning wordt alleen doorgevoerd als de optie 'Inschakelen' is aangevinkt.

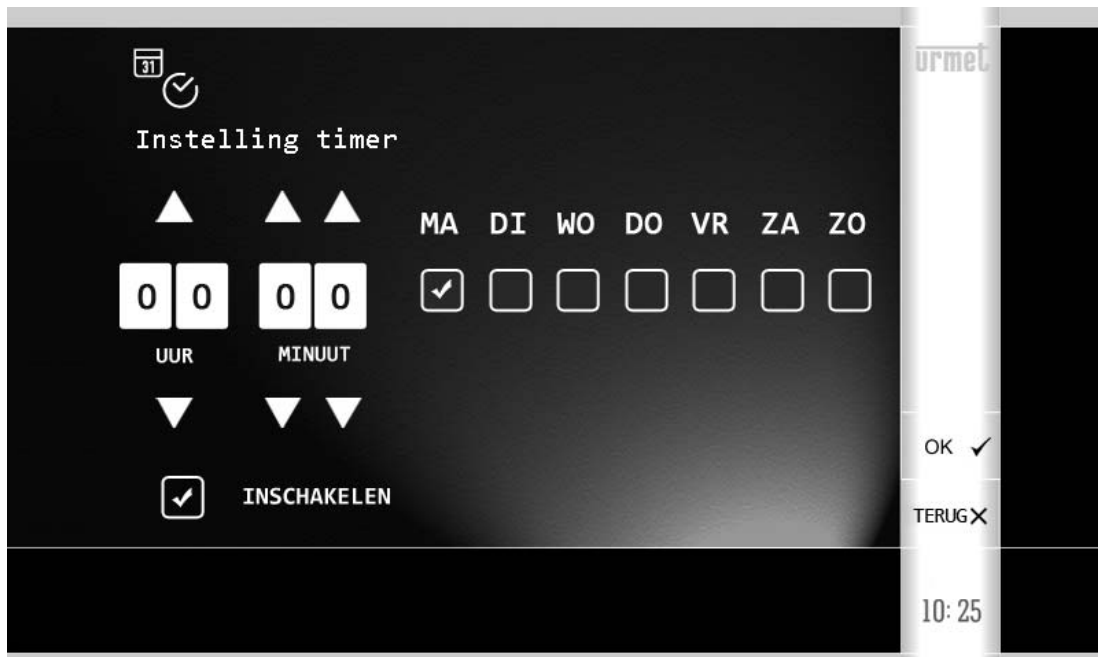

Tik 2 keer op 'OK' om de wijzigingen te bevestigen en vervolgens 2 keer op 'TERUG' om terug te keren naar de Home Page.

Voor meer informatie, scan de QR-code met de fotocamera van uw smartphone of tablet:







**DS1722-080A**

URMET S.p.A.  
10154 TORINO (ITALY)  
VIA BOLOGNA 188/C  
Telef. +39 011.24.00.000 (RIC.AUT.)  
Fax +39 011.24.00.300 - 323

**urmet**

**LBT20132**

Area tecnica  
servizio clienti +39 011.23.39.810  
<http://www.urmet.com>  
e-mail: [info@urmet.com](mailto:info@urmet.com)